

COS/MOS INTEGRATED CIRCUIT

www.DataSheet4U.com

4045 B

HCC/HCF 4045B

COS/MOS 21-STAGE COUNTER

- VERY LOW OPERATING DISSIPATION 1 mW (TYP.); @ $V_{DD} = 5V$, $f_{\phi} = 1$ MHz
- OUTPUT DRIVERS WITH SINK OR SOURCE CAPABILITY 7 mA (TYP.) @ $V_{DD} = 5V$
- MEDIUM SPEED (TYP.) $f_{\phi} = 16$ MHz, @ $V_{DD} = 10V$
- QUIESCENT CURRENT SPECIFIED TO 20V FOR HCC DEVICE
- 5V, 10V, AND 15V PARAMETRIC RATINGS
- INPUT CURRENT OF 100 nA AT 18V AND 25°C FOR HCC DEVICE
- 100% TESTED FOR QUIESCENT CURRENT
- MEETS ALL REQUIREMENTS OF JEDEC TENTATIVE STANDARD NO. 13A, "STANDARD SPECIFICATIONS FOR DESCRIPTION OF "B" SERIES CMOS DEVICES"

The **HCC 4045B** (extended temperature range) and **HCF 4045B** (intermediate temperature range) are monolithic integrated circuits, available in 16-lead dual in-line plastic or ceramic package and ceramic flat package. The **HCC/HCF 4045B** is a timing circuit consisting of 21 counter stages, two output-shaping flip-flops, two inverter output drivers, and input inverters for use in a crystal oscillator. The **HCC/HCF 4045B** configuration provides 21 flip-flop counting stages, and two flip-flops for shaping the output waveform for a 3.125% duty cycle. Push-pull operation is provided by the inverter output drivers. The first inverter is intended for use as a crystal oscillator-amplifier. However, it may be used as a normal logic inverter if desired. A crystal oscillator circuit can be made less sensitive to voltage-supply variations by the use of source resistors. In this device, the sources of the p and n transistors have been brought out to package terminals. If external resistors are not required, the sources must be shorted to their respective substrates (S_p to V_{DD} , S_n to V_{SS}).

ABSOLUTE MAXIMUM RATINGS

V_{DD}^*	Supply voltage: HCC types HCF types	-0.5 to 20	V
		-0.5 to 18	V
V_i	Input voltage	-0.5 to $V_{DD} + 0.5$	V
I_i	DC input current (any one input)	± 10	mA
P_{tot}	Total power dissipation (per package)	200	mW
	Dissipation per output transistor for $T_{op} =$ full package-temperature range	100	mW
T_{op}	Operating temperature: HCC types HCF types	-55 to 125	°C
		-40 to 85	°C
T_{stg}	Storage temperature	-65 to 150	°C

* All voltage values are referred to V_{SS} pin voltage

ORDERING NUMBERS:

- HCC 4045 BD for dual in-line ceramic package
- HCC 4045 BF for dual in-line ceramic package, frit seal
- HCC 4045 BK for ceramic flat package
- HCF 4045 BE for dual in-line plastic package
- HCF 4045 BF for dual in-line ceramic package, frit seal

www.DataSheet4U.com

MECHANICAL DATA (dimensions in mm)

Dual in-line ceramic package for HCC 4045 BD

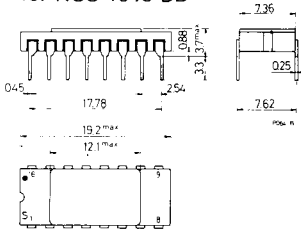

Dual in-line ceramic package for HCC/HCF 4045 BF

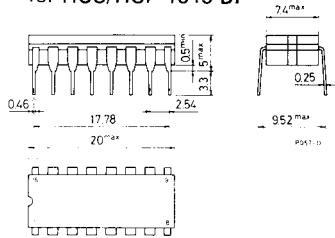

Dual in-line plastic package for HCF 4045 BE

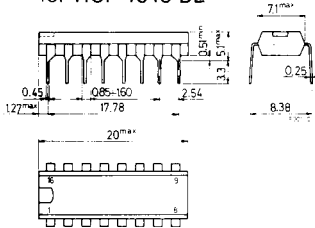

Ceramic flat package for HCC 4045 BK

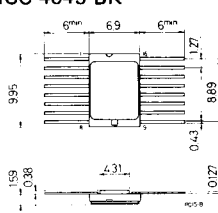

CONNECTION DIAGRAM

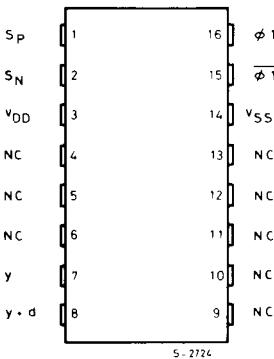

LOGIC DIAGRAM

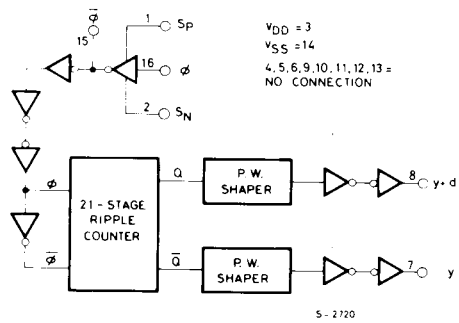

RECOMMENDED OPERATING CONDITIONS

V_{DD}	Supply voltage: HCC types HCF types	3 to 18	V
V_I	Input voltage	3 to 15	V
T_{op}	Operating temperature: HCC types HCF types	0 to V_{DD} -40 to +85	V °C °C

Handwritten notes: *4045B* and *2402*

STATIC ELECTRICAL CHARACTERISTICS (over recommended operating conditions)

Parameter		Test conditions				Values						Unit	
		V _I (V)	V _O (V)	I _O (μA)	V _{DD} (V)	T _{Low} *		25°C			T _{High} *		
						Min.	Max.	Min.	Typ.	Max.	Min.		Max.
I _L	Quiescent current	HCC types	0/ 5			5		5		0.04	5		150
			0/10			10		10		0.04	10		300
			0/15			15		20		0.04	20		600
	HCF types	0/ 5			5		20		0.08	100		3000	
		0/10			10		40		0.04	40		300	
		0/15			15		80		0.04	80		600	
V _{OH}	Output high voltage	0/ 5		< 1	5	4.95		4.95			4.95		
		0/10		< 1	10	9.95		9.95			9.95		
		0/15		< 1	15	14.95		14.95			14.95		
V _{OL}	Output low voltage	5/0		< 1	5		0.05			0.05		0.05	
		10/0		< 1	10		0.05			0.05		0.05	
		15/0		< 1	15		0.05			0.05		0.05	
V _{IH}	Input high voltage		0.5/4.5	< 1	5	3.5		3.5			3.5		
			1/9	< 1	10	7		7			7		
			1.5/13.5	< 1	15	11		11			11		
V _{IL}	Input low voltage		4.5/0.5	< 1	5		1.5			1.5		1.5	
			9/1	< 1	10		3			3		3	
			13.5/1.5	< 1	15		4			4		4	
I _{OH}	Output drive current	HCC types	0/ 5	4.6		5	-4.5		-3.6	-7		-2.5	
			0/10	9.5		10	-11.2		-9.1	-18		-6.3	
			0/15	13.5		15	-29.4		-23.8	-47		-16.8	
	HCF types	0/ 5	4.6		5	-3.6		-3	-7		-2.46		
		0/10	9.5		10	-8.9		-7.7	-18		-6.54		
		0/15	13.5		15	-23.8		-20	-47		-16.6		
I _{OL}	Output sink current	HCC types	0/ 5	0.4		5	4.5		3.6	7		2.5	
			0/10	0.5		10	11.2		9.1	18		6.3	
			0/15	1.5		15	29.4		23.8	47		16.8	
	HCF types	0/ 5	0.4		5	3.6		3	7		2.46		
		0/10	0.5		10	8.9		7.7	18		6.54		
		0/15	1.5		15	23.8		20	47		16.6		
I _{IH} , I _{IL}	Input leakage current	HCC types	0/18	Any input	18		±0.1		±10 ⁻⁵	±0.1		± 1	
		HCF types	0/15		15		±0.3		±10 ⁻⁵	±0.3		± 1	
C _I	Input capacitance		Any input						5	7.5		pF	

* T_{Low} = - 55°C for **HCC** device; -40°C for **HCF** device.
 * T_{High} = +125°C for **HCC** device; +85°C for **HCF** device.
 The Noise Margin for both "1" and "0" level is:
 1V min. with V_{DD} = 5V
 2V min. with V_{DD} = 10V
 2.5V min. with V_{DD} = 15V

REWORKED
S

DYNAMIC ELECTRICAL CHARACTERISTICS ($T_{amb} = 25^{\circ}C$, $C_L = 50$ pF, $R_L = 200$ k Ω , typical temperature coefficient for all $V_{DD} = 0.3\%/^{\circ}C$ values, all input rise and fall time = 20 ns)

Parameter	Test conditions	Values			Unit	
		$V_{DD}(V)$	Min.	Typ.		Max.
t_{PLH} , t_{PHL} Propagation delay time ϕ to y or y + d out		5		2.2	5.5	μs
		10		0.9	2.7	
		15		0.65	2	
t_{THL} , t_{TLH} Transition time		5		25	50	ns
		10		13	25	
		15		10	20	
f_{max} Maximum input pulse frequency External pulse source		5	5	10		MHz
		10	12	25		
		15	15	30		
t_w Input pulse width		5		50	100	ns
		10		25	50	
		15		20	40	
t_r, t_f Clock input rise or fall time		5			500	μs
		10			500	
		15			500	
Variation of output frequency (Unit to unit)	$f = 5$ MHz	5		0.05		%
		10		0.03		
		15		0.1		

RC OSCILLATOR OPERATION

f_{osc} Maximum oscillator frequency (see fig. below left)	$R_X = 50$ K Ω $R_S = 560$ K Ω $C_X = 50$ pF	Values			Unit
		5	10	15	
		45	60	75	KHz
		45	60	75	
		45	60	75	

TYPICAL APPLICATIONS

Digital equipment in which ultra-low dissipation and/or operation using a battery source are primary design requirements.

Accurate timing from a crystal oscillator for timing applications such as wall clocks, table clocks, automobile clocks, and digital timing references in any circuit requiring accurately timed outputs at various intervals in the counting sequence.

Driving miniature synchronous motors, stepping motors, or external bipolar transistors in push-pull fashion.

Typical RC circuit

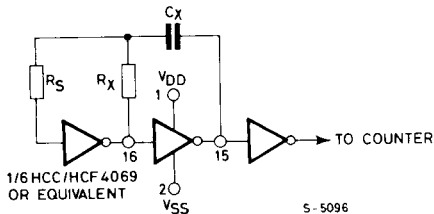

S-5096

Electronic watch application circuit

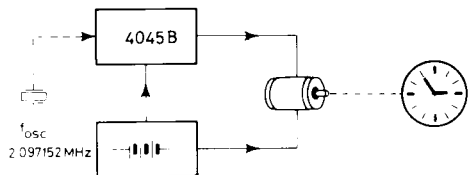

S-2725

